

Getting the most out of our systems

We want to make it simple and easy for you to protect your clients. From OLP Connect to our Existing Business Agent Hub, our systems are designed to help you get them on risk quicker, prevent lapses, and protect more clients.

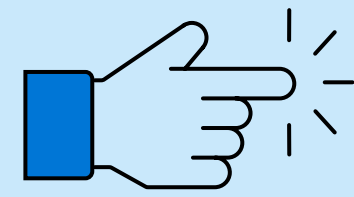

Getting started

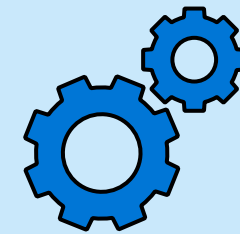

System overview

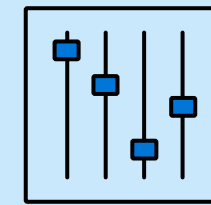

Contact preferences



Quote and apply

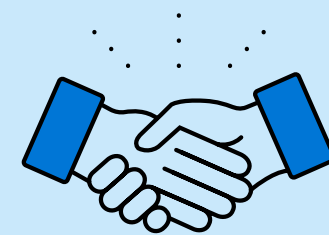

Handoff

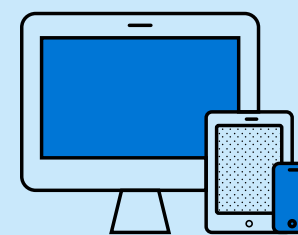

Online Trusts

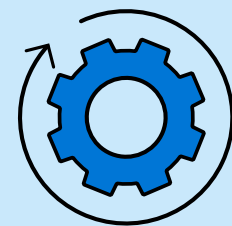

Amending application

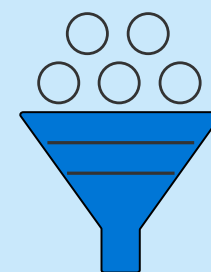

Pipeline management



Retention

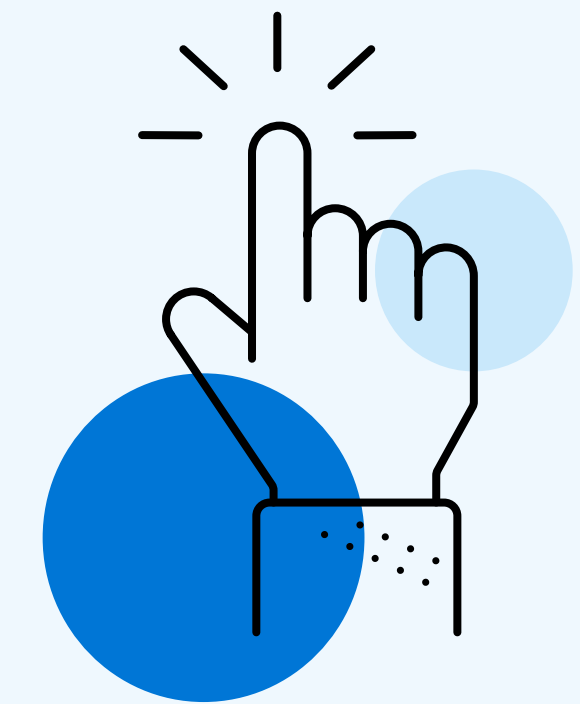

**Click each step to see
more information**

For Adviser use only

Legal & General Assurance Society Limited. Registered in England and Wales No. 00166055. Registered office: One Coleman Street, London EC2R 5AA.
We are authorised by the Prudential Regulation Authority and regulated by the Financial Conduct Authority and the Prudential Regulation Authority.

3527735 10/23

Getting the most out of our systems

We want to make it simple and easy for you to protect your clients. From OLP Connect to our Existing Business Agent Hub, our systems are designed to help you get them on risk quicker, prevent lapses, and protect more clients.

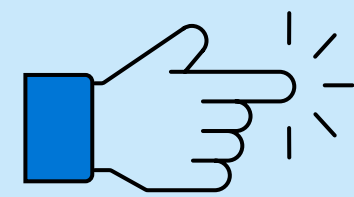
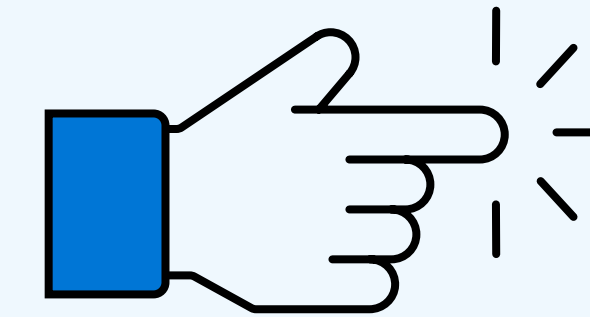

Getting started

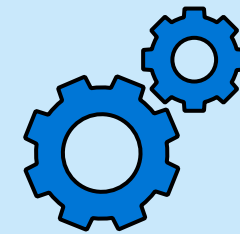

System overview

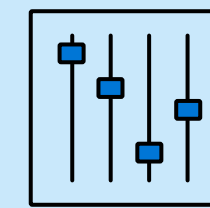

Contact preferences



Quote and apply

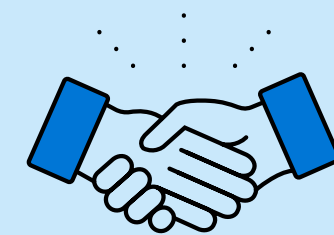

Handoff

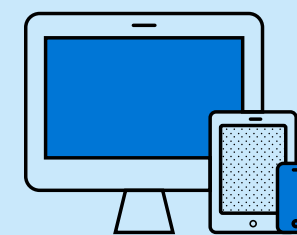

Online Trusts

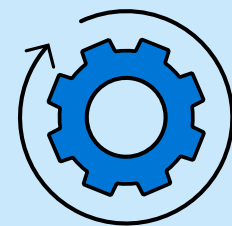

Amending application

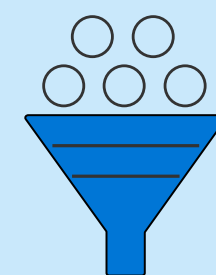

Pipeline management



Retention

Getting started

Our secure login page makes accessing your Legal & General account quick and simple.

- Your Agency Number is your key to accessing our online systems
- Register in less than five minutes
- Provides access for admin users and shared agency number users.

More information

[How to register and log in](#)

[How to set up online access](#)

[Registration FAQs](#)

For Adviser use only

Legal & General Assurance Society Limited. Registered in England and Wales No. 00166055. Registered office: One Coleman Street, London EC2R 5AA. We are authorised by the Prudential Regulation Authority and regulated by the Financial Conduct Authority and the Prudential Regulation Authority.

Getting the most out of our systems

We want to make it simple and easy for you to protect your clients. From OLP Connect to our Existing Business Agent Hub, our systems are designed to help you get them on risk quicker, prevent lapses, and protect more clients.

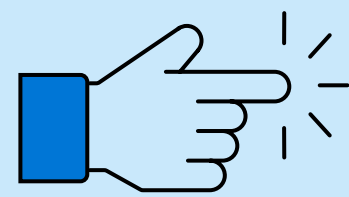
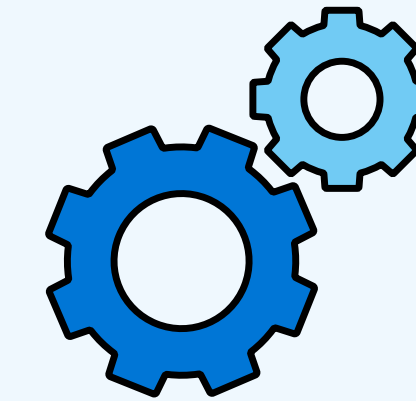

Getting started

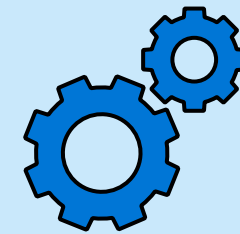

System overview

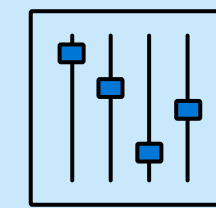

Contact preferences



Quote and apply

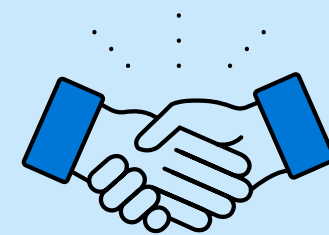

Handoff

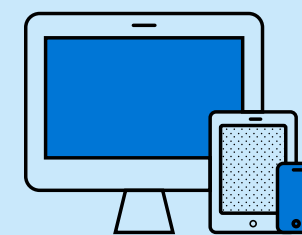

Online Trusts

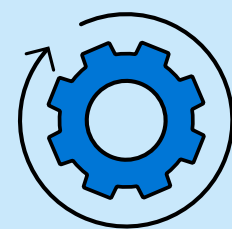

Amending application

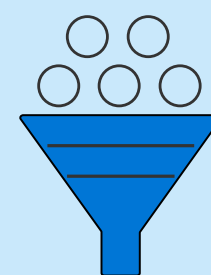

Pipeline management



Retention

System overview

OLP Connect is your single log in and application and client pipeline management system.

- Gives instant decisions in around 83% of cases
- Visibility of all your Legal & General customers
- Instant support available through our live chat team
- Access to daily passcode.

More information

[Systems overview one pager](#)

[Benefits of using live chat](#)

[Recent service changes webpage](#)

For Adviser use only

Legal & General Assurance Society Limited. Registered in England and Wales No. 00166055. Registered office: One Coleman Street, London EC2R 5AA. We are authorised by the Prudential Regulation Authority and regulated by the Financial Conduct Authority and the Prudential Regulation Authority.

Getting the most out of our systems

We want to make it simple and easy for you to protect your clients. From OLP Connect to our Existing Business Agent Hub, our systems are designed to help you get them on risk quicker, prevent lapses, and protect more clients.

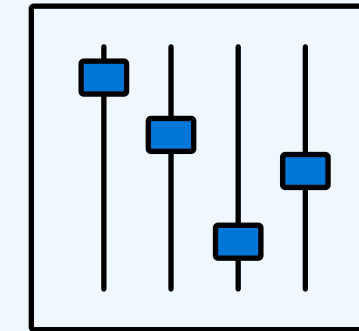

 <p>Getting started</p>	 <p>System overview</p>	 <p>Contact preferences</p>
 <p>Quote and apply</p>	 <p>Handoff</p>	 <p>Online Trusts</p>
 <p>Amending application</p>	 <p>Pipeline management</p>	 <p>Retention</p>

Setting contact preferences

Customise your contact and communications preferences. We can send communications to you and/or your clients, or your administrator.

- Receive notifications on your applications in pipeline
- Flexibility to choose what communications your customers receive
- Receive notifications on your client's lapsed or cancelled policies.

More information

[How to set up your contact preferences](#)

[How to amend preferences for individual applications](#)

For Adviser use only

Legal & General Assurance Society Limited. Registered in England and Wales No. 00166055. Registered office: One Coleman Street, London EC2R 5AA. We are authorised by the Prudential Regulation Authority and regulated by the Financial Conduct Authority and the Prudential Regulation Authority.

Getting the most out of our systems

We want to make it simple and easy for you to protect your clients. From OLP Connect to our Existing Business Agent Hub, our systems are designed to help you get them on risk quicker, prevent lapses, and protect more clients.

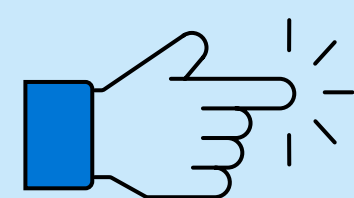

Getting started

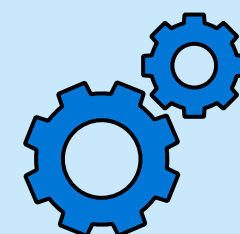

System overview

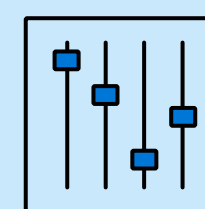

Contact preferences



Quote and apply

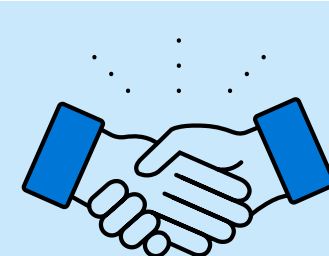

Handoff

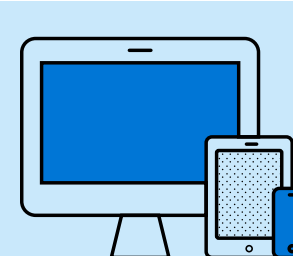

Online Trusts

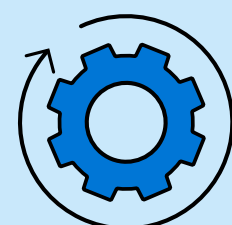

Amending application

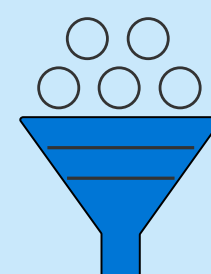

Pipeline management



Retention

Quote and apply

It's easy to get a quote and submit an application in OLP Connect.

- Our pre-sale underwriting tool gives you a fast and accurate indicative decision
- Average of 2.5k BMI indications provided immediately every month
- Pre-Sales Underwriting pre-submission form for indication of terms take on average less than one hour
- Apply for multiple products through one application.

More information

[How to use our pre-sale underwriting guide](#)

[Pre-sale underwriting tool](#)

[How to get a quote](#)

[Starting a Policy](#)

[Accepting a Decision](#)

For Adviser use only

Legal & General Assurance Society Limited. Registered in England and Wales No. 00166055. Registered office: One Coleman Street, London EC2R 5AA. We are authorised by the Prudential Regulation Authority and regulated by the Financial Conduct Authority and the Prudential Regulation Authority.

Getting the most out of our systems

We want to make it simple and easy for you to protect your clients. From OLP Connect to our Existing Business Agent Hub, our systems are designed to help you get them on risk quicker, prevent lapses, and protect more clients.

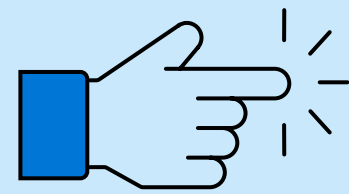

Getting started

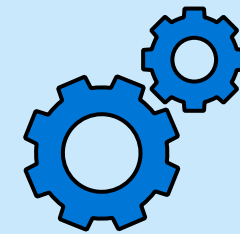

System overview

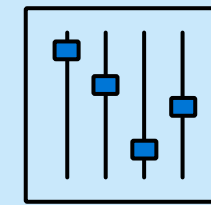

Contact preferences



Quote and apply

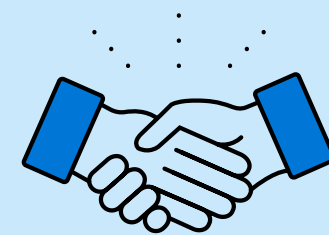

Handoff



Online Trusts

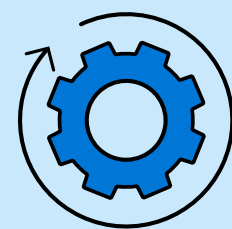

Amending application

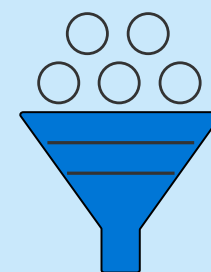

Pipeline management



Retention

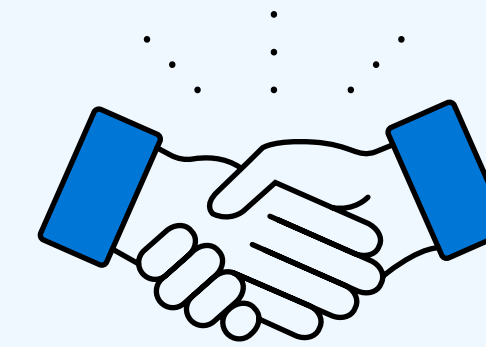

Handoff

You can hand off the health and lifestyle questions to your client, to let them complete it when it suits them. They then hand back the completed form for you to submit for the decision/outcome.

More information

[More about our handoff service](#)

For Adviser use only

Legal & General Assurance Society Limited. Registered in England and Wales No. 00166055. Registered office: One Coleman Street, London EC2R 5AA. We are authorised by the Prudential Regulation Authority and regulated by the Financial Conduct Authority and the Prudential Regulation Authority.

Getting the most out of our systems

We want to make it simple and easy for you to protect your clients. From OLP Connect to our Existing Business Agent Hub, our systems are designed to help you get them on risk quicker, prevent lapses, and protect more clients.

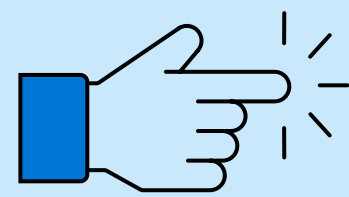

Getting started

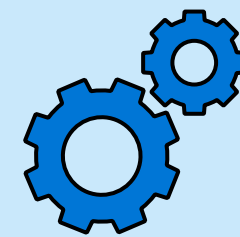

System overview

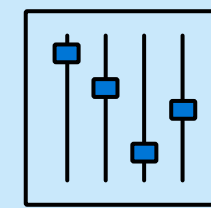

Contact preferences



Quote and apply

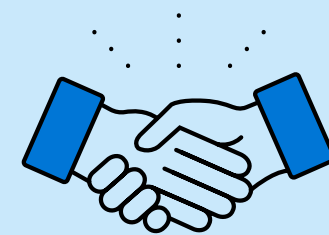

Handoff

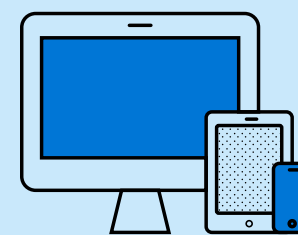

Online Trusts

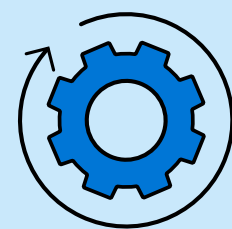

Amending application

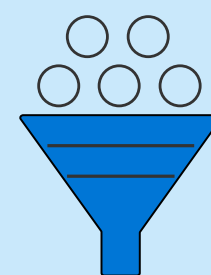

Pipeline management



Retention

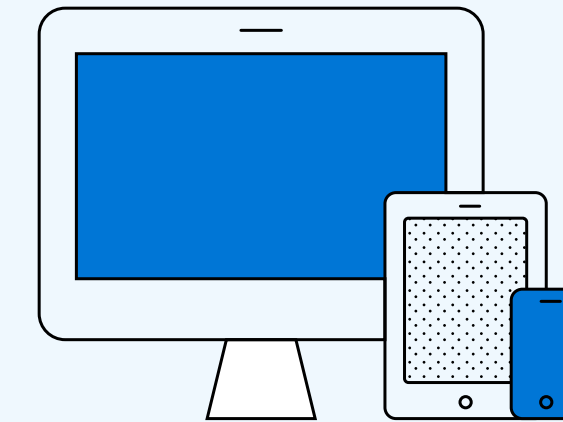

Online Trusts

It's easy to set up a trust using OLP Connect. You can complete your trust form in the application journey.

- No need for signatures and witnesses
- All completed within OLP Connect
- Multiple trust options.

More information

[Trust hub](#)

[How to set up a trust](#)

For Adviser use only

Legal & General Assurance Society Limited. Registered in England and Wales No. 00166055. Registered office: One Coleman Street, London EC2R 5AA. We are authorised by the Prudential Regulation Authority and regulated by the Financial Conduct Authority and the Prudential Regulation Authority.

Getting the most out of our systems

We want to make it simple and easy for you to protect your clients. From OLP Connect to our Existing Business Agent Hub, our systems are designed to help you get them on risk quicker, prevent lapses, and protect more clients.

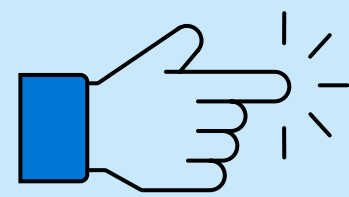

Getting started

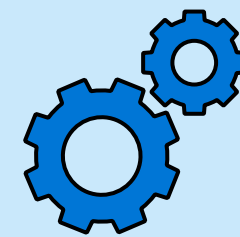

System overview

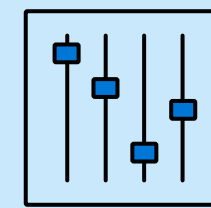

Contact preferences

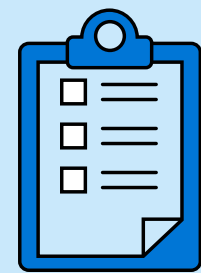

Quote and apply

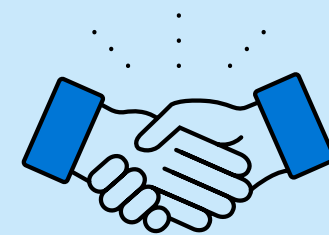

Handoff

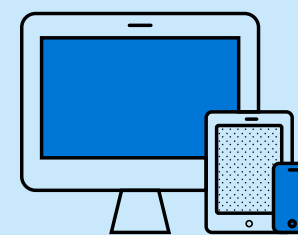

Online Trusts

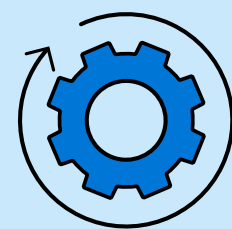

Amending application

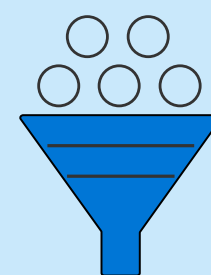

Pipeline management



Retention

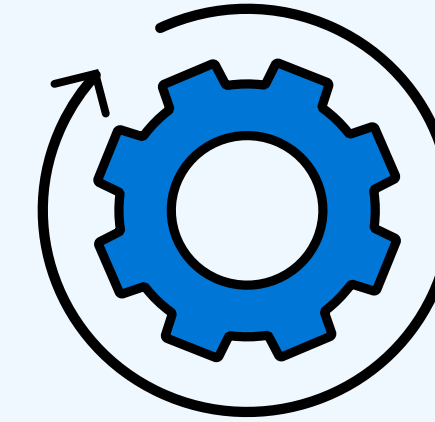

Amending an application

You can make changes to your client's application in OLP Connect before it's completed.

- Quick and simple to do
- Amend a product whether it's a change in circumstances, a product amend or providing more information.

More information

[How to amend an application](#)

For Adviser use only

Legal & General Assurance Society Limited. Registered in England and Wales No. 00166055. Registered office: One Coleman Street, London EC2R 5AA. We are authorised by the Prudential Regulation Authority and regulated by the Financial Conduct Authority and the Prudential Regulation Authority.

Getting the most out of our systems

We want to make it simple and easy for you to protect your clients. From OLP Connect to our Existing Business Agent Hub, our systems are designed to help you get them on risk quicker, prevent lapses, and protect more clients.

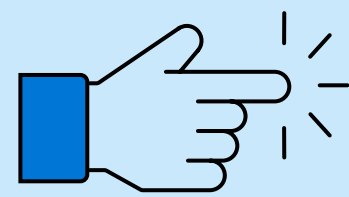

Getting started

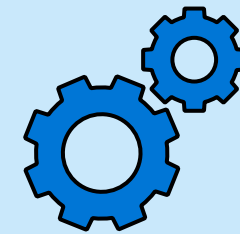

System overview

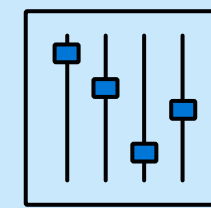

Contact preferences



Quote and apply

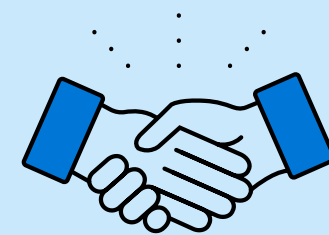

Handoff

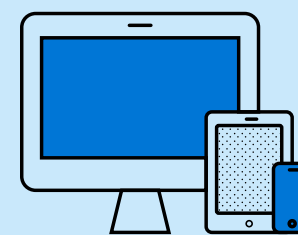

Online Trusts

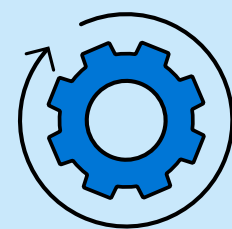

Amending application

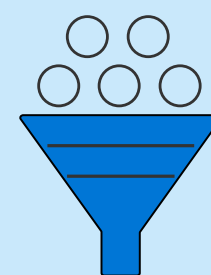

Pipeline management



Retention

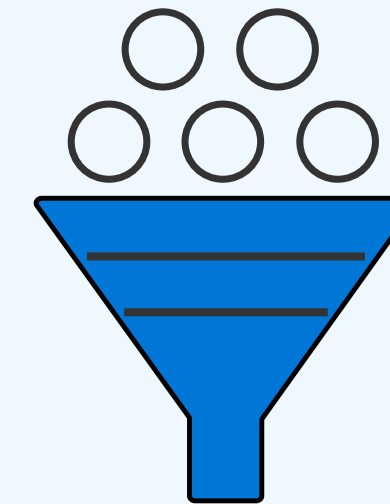

Pipeline management

Get full updates from application to completion by visiting our Agent Hub.

- Our progress bar shows an easy-to-understand view of what evidence or requirements are needed to progress an application
- Complete an online Declaration of Health
- Put a policy on Risk once a decision has been made
- Support is available through our Live Chat Team with any new business queries.

More information

[Agent Hub training videos](#)

[Guide to live chat](#)

[Accessing documents](#)

For Adviser use only

Legal & General Assurance Society Limited. Registered in England and Wales No. 00166055. Registered office: One Coleman Street, London EC2R 5AA. We are authorised by the Prudential Regulation Authority and regulated by the Financial Conduct Authority and the Prudential Regulation Authority.

Getting the most out of our systems

We want to make it simple and easy for you to protect your clients. From OLP Connect to our Existing Business Agent Hub, our systems are designed to help you get them on risk quicker, prevent lapses, and protect more clients.

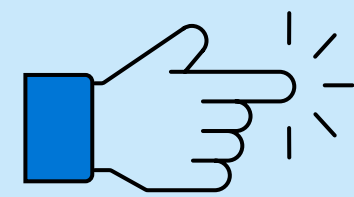

Getting started

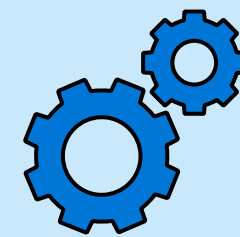

System overview

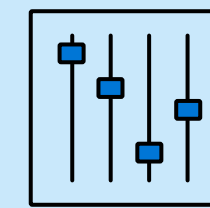

Contact preferences



Quote and apply

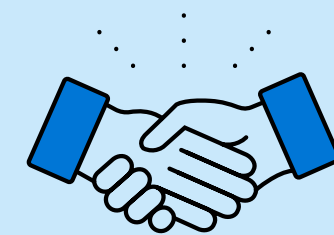

Handoff

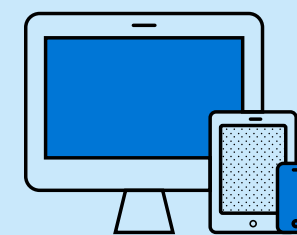

Online Trusts

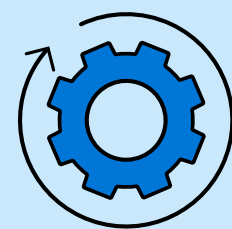

Amending application

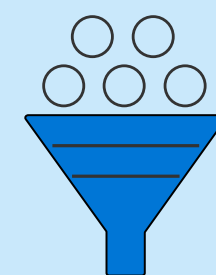

Pipeline management



Retention

Retention

One in 10 new policies will be cancelled from outset, so keep up to date on policy information in our Existing Business Agent Hub.

- Last year we retained 66,754 policies saving you £2,277,014 in potentially lost commission
- Receive same-day notifications if a Direct Debit Mandate cancels or bounces, so your clients stay protected
- Set up an active retention email address.

More information

[Why you should set up lapse notifications](#)

[How to reinstate a direct debit](#)

[Interactive retentions sales aid](#)

For Adviser use only

Legal & General Assurance Society Limited. Registered in England and Wales No. 00166055. Registered office: One Coleman Street, London EC2R 5AA. We are authorised by the Prudential Regulation Authority and regulated by the Financial Conduct Authority and the Prudential Regulation Authority.